

Bigscreen Beyond. User Guide

EN

bigscreen

WHAT'S INSIDE THE BOX?

Your Beyond comes with the following items, which you'll use to experience immersive VR environment

- Bigscreen Beyond Headset
- Custom Face Cushion
- Soft Strap
- Link Box (2 USB3.0 A, 1 DisplayPort 1.4)
- Fiber Optic Cable (5 meters)
- Cleaning Cloth

BEFORE YOU START CHECKLIST

Before we dive into the exciting world of Beyond, let's first make sure you have what you need.

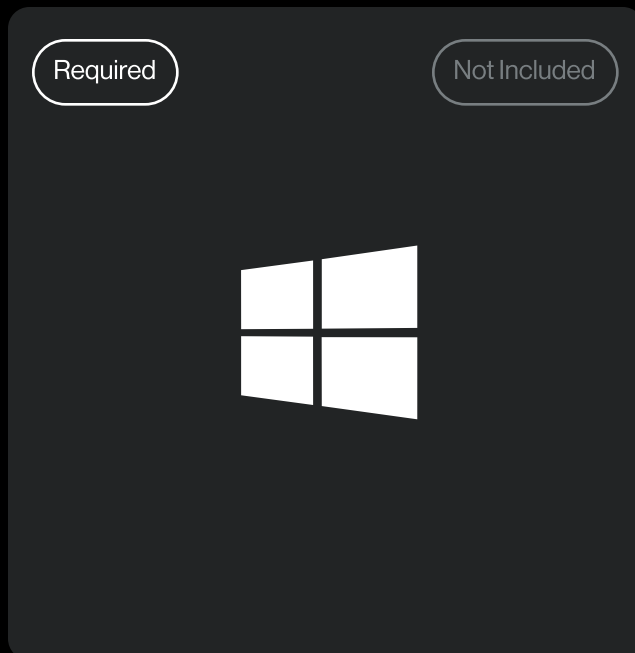

VR-Ready Windows PC

A Windows gaming PC is required to run VR games and applications. Minimum specifications include Windows 10 or 11, a quad-core CPU, and an Nvidia (RTX 2070 or newer) or AMD (RX 5700 or newer) graphics card.

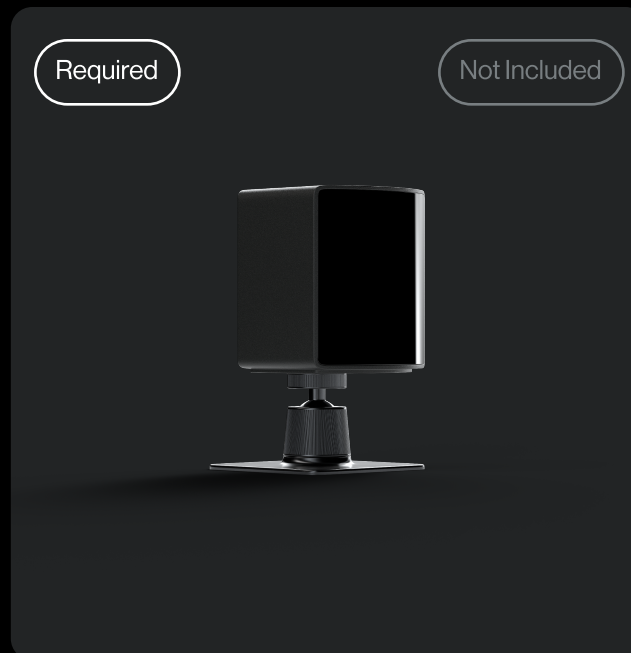

SteamVR Controllers

Beyond is compatible with all SteamVR controllers such as the Valve Index controllers. Controllers are not included with the Beyond, and are required for playing most VR games.

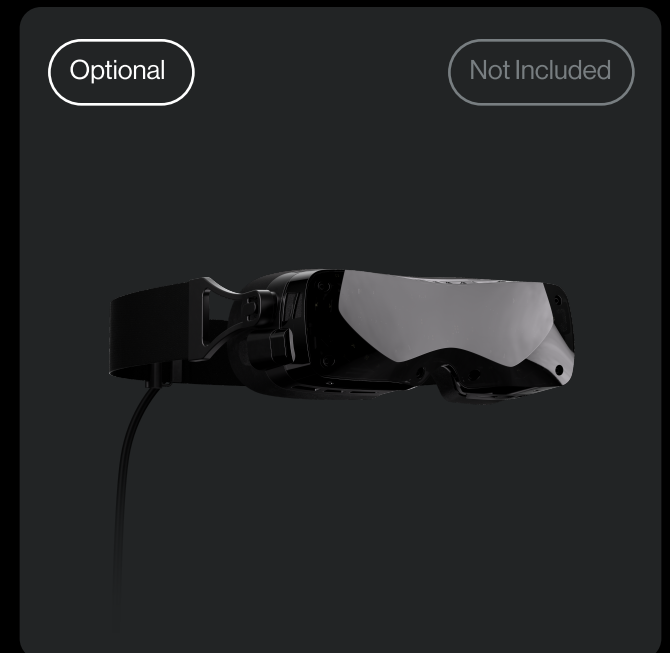

SteamVR Base Stations

Beyond requires SteamVR Base Stations for headset and controller tracking. These devices track the headset in 3D space and enable VR experiences. SteamVR Base Stations can be purchased from the Steam Store.

UNBOXING & CONNECTING THE HEADSET

Inside the box, you'll find the following components: your Beyond, your custom-made face cushion, a 5-meter fiber optic USB-C Cable, and the Link box.

Connecting the cable

It's important to note the 5-meter Beyond cable is not reversible. One side of the cable must be plugged into the headset, while the other side must be connected to the Link Bo

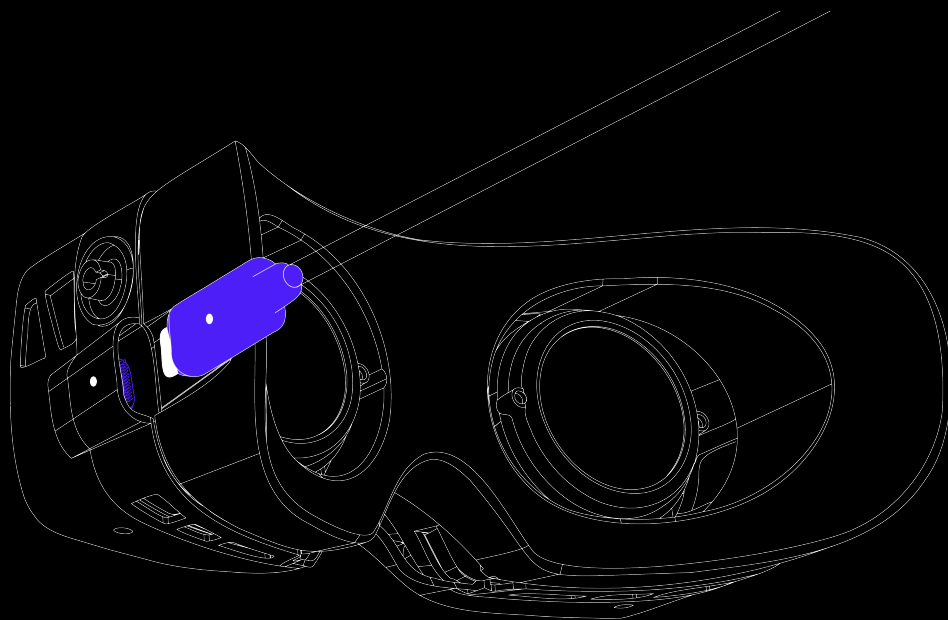

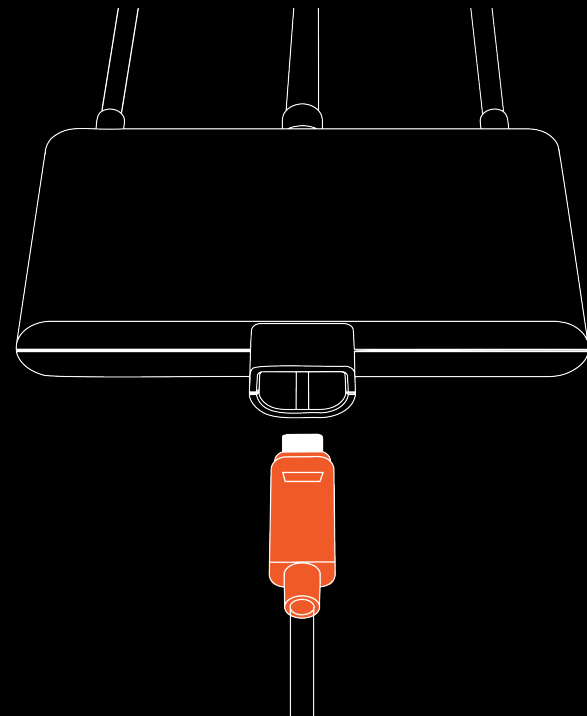

The side of the cable with the  purple label and a dot plugs into the USB-C port on the left side of the headset. Beyond will not turn on if you incorrectly connect the cable to the right side USB-C port, which can be used for accessories such as the Audio Strap.



The side of the cable with an  orange label and a D-shaped plug connects to the Link Box, which has a matching D-shaped slot. Since the cable is not reversible, Beyond will not function correctly if you connect this side of the cable to the headset.

Connecting the Link Box to your PC

Connect the two USB 3.0 cables  on the Link Box to two USB 3.0 ports on your computer. The Link Box's DisplayPort 1.4 cable  must be connected directly to the Nvidia or AMD graphics card on your computer, and should not be plugged into your motherboard. If you're using a laptop, you will either need a Mini-DisplayPort to Displayport 1.4 adapter, or if your laptop has USB-C DisplayPort (also known as DP Alt Mode), you will need a USB-C to DisplayPort 1.4 adapter.

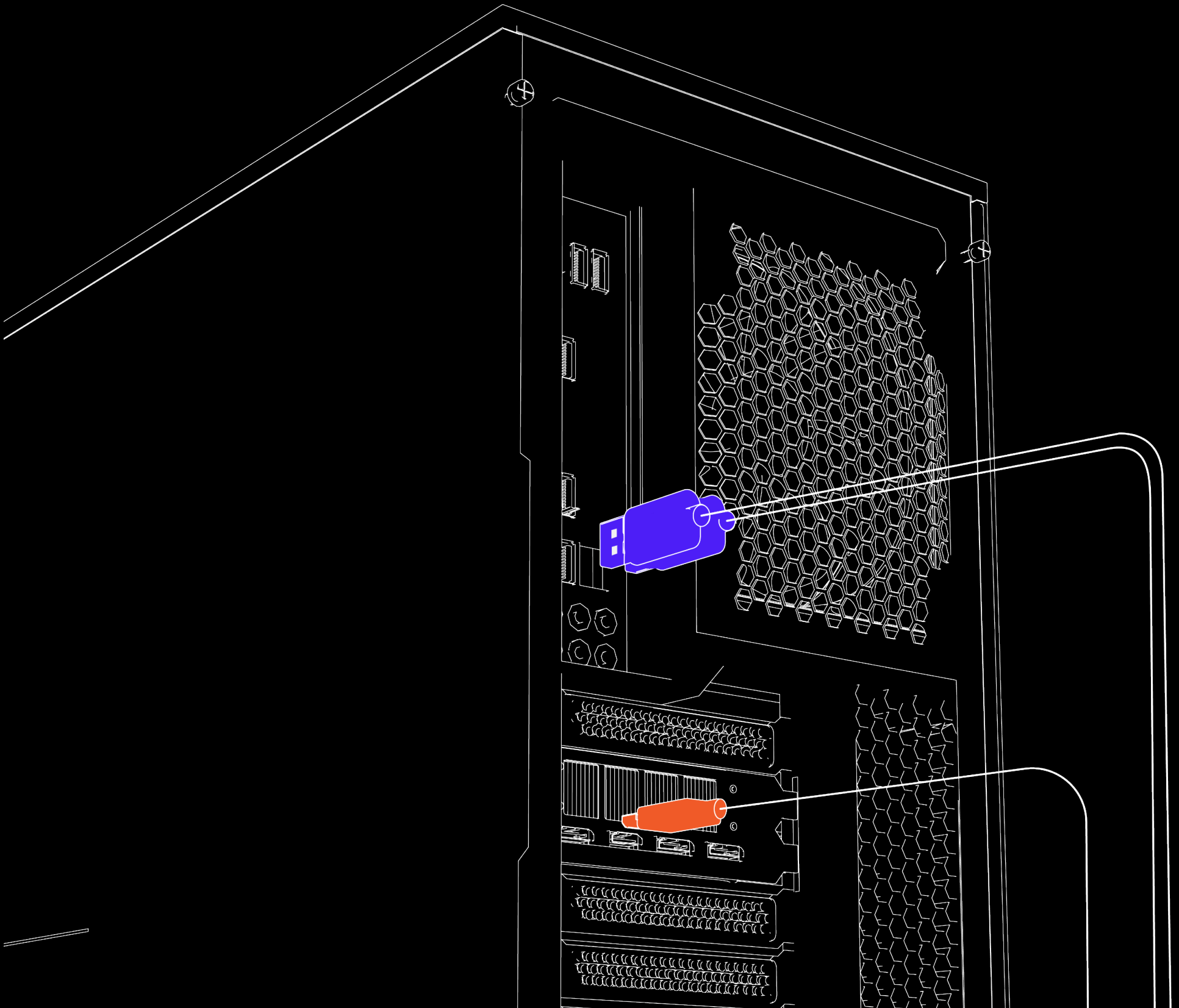

Adjusting the Soft Strap

Find the right tightness for a comfortable Beyond experience. For improved ergonomics, try attaching the included Top Strap to the Soft Strap. For ultimate comfort and built-in headphones, we recommend buying the [Bigscreen Beyond Audio Strap](#).

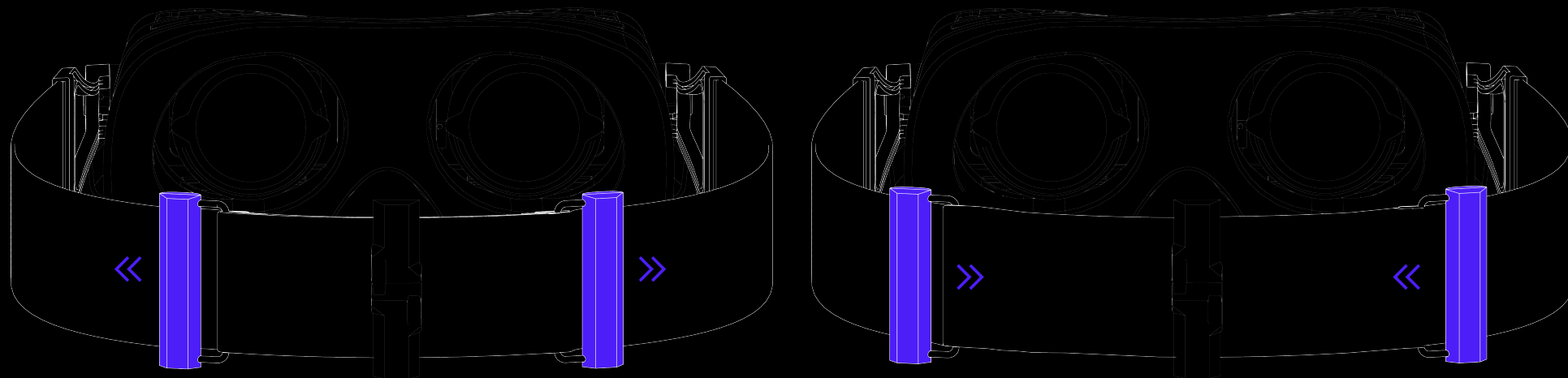

Tightening the Strap

Grab each of the strap clips ● with your thumbs and index fingers. Simultaneously pull both strap clips outward to tighten the strap.

Loosening the Strap

To loosen, grab both strap clips ● with your thumbs and index fingers and reverse the process: simultaneously pull both strap clips inward.

Clipping the cable to the Soft Strap

The Soft Strap has a Cable Clip. Slide the cable through it and the cable will be held rigidly. This lets you route the cable behind your back for improved ergonomics. It's important to leave enough length of cable near the left-side of the headset to allow unrestricted head movement.

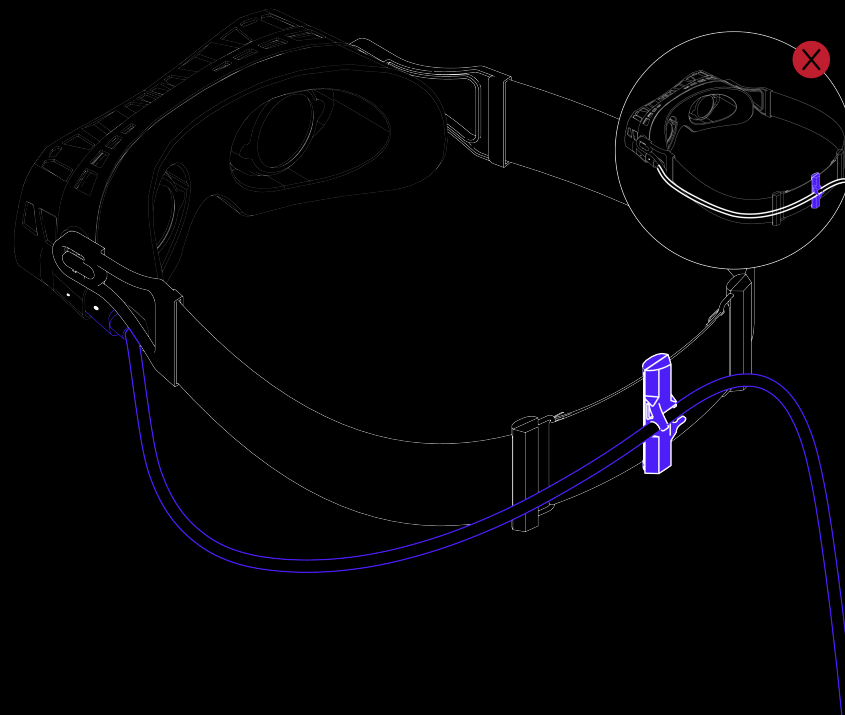

Installing Your Top Strap

The top strap is an optional accessory designed to enhance comfort. While it's not mandatory for use, you may find it beneficial. Installing the top strap is a straightforward process involving three simple steps.

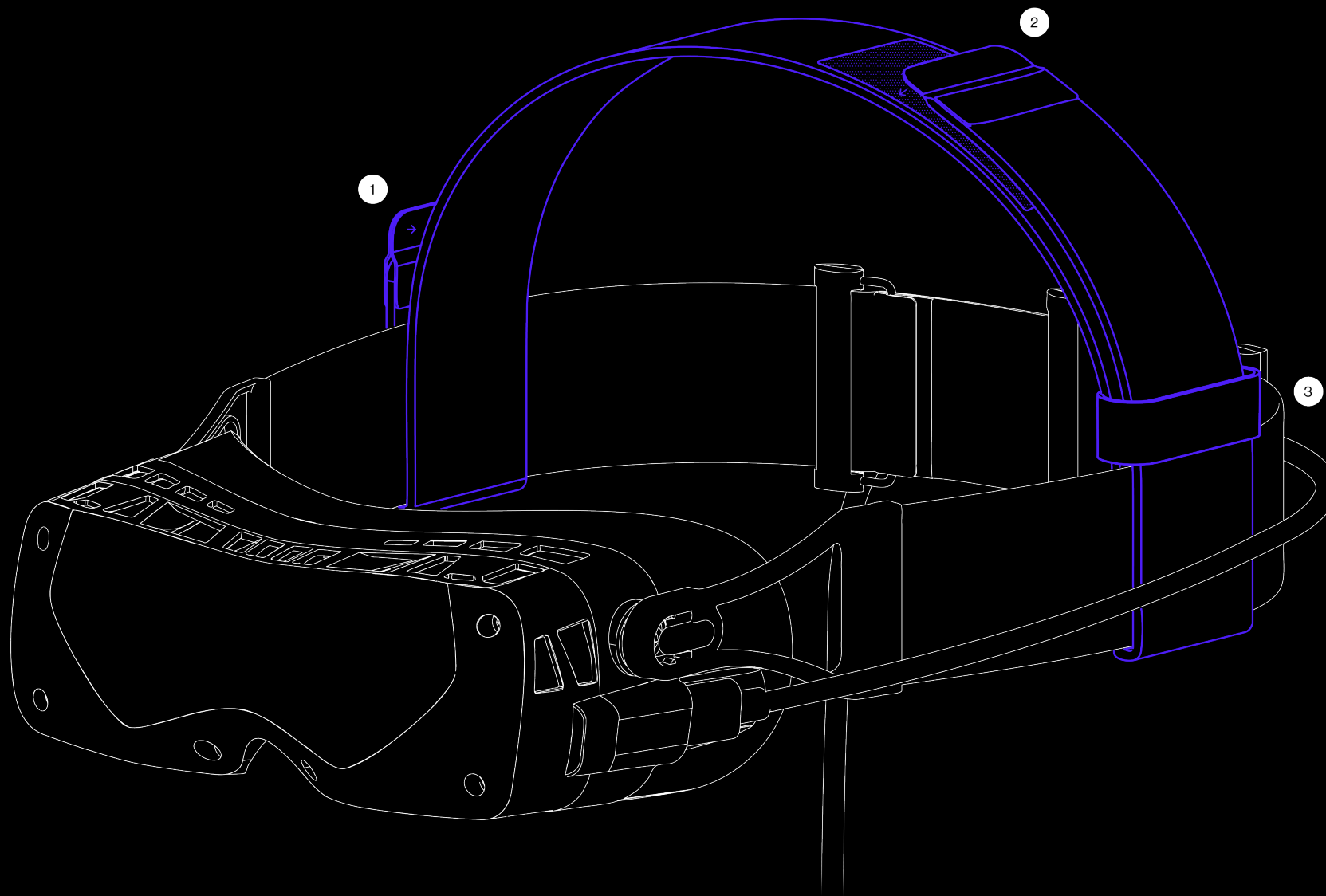

❶ Attaching the Velcro Ends

Start by identifying the two Velcro sides of the top strap. One side has a "short patch" of Velcro, and the other has a "long patch." Take the "short patch" end, loop it under one side of the soft strap, and wrap it around until the Velcro parts meet and attach securely. Do the same with the "long patch" end, attaching it to a convenient part of its longer Velcro patch.

❷ Adjusting for Comfortable Fit

Next, place the strap with the Beyond on your head. For a comfortable fit, unstick the "long patch" end and adjust its length as needed. Move your head gently to check the fit, making sure the strap holds well without any discomfort.

❸ Securing the Strap in Place with extra velcro

To finalize the installation, wrap the "short strap" — a small Velcro strip that comes with the top strap — around the base of the "long patch" end. This step is essential to keep the strap firmly in position and prevent any slipping during use.

DOWNLOAD STEAM AND INSTALL STEAMVR

Beyond works with all the VR games and applications on Windows PCs. To get started, you'll need to install SteamVR from Steam.

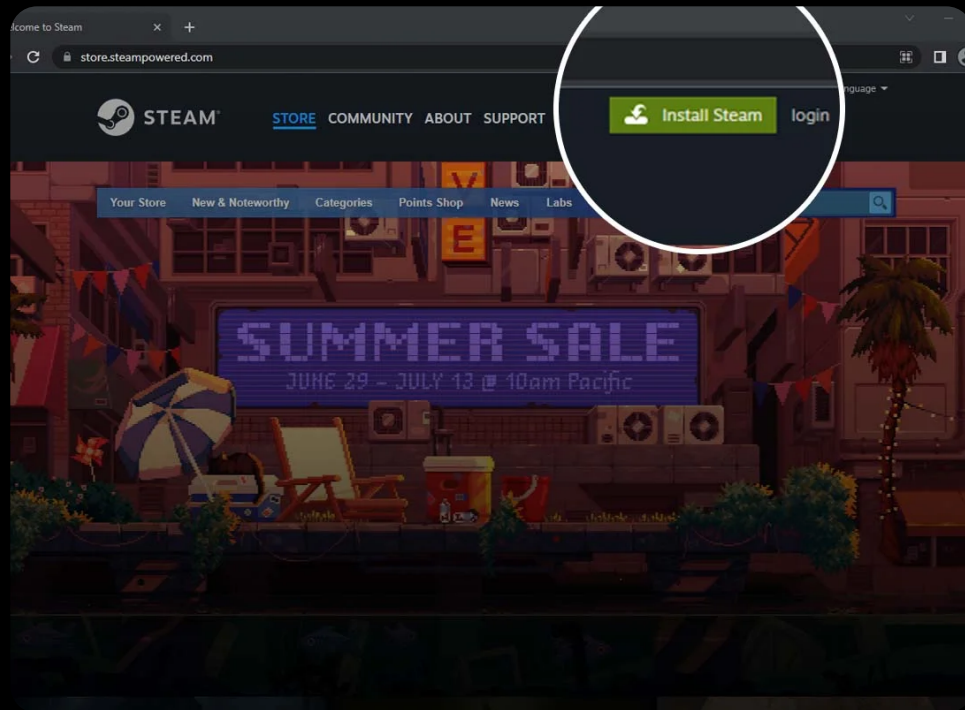

Downloading Steam

Visit [steampowered.com](https://store.steampowered.com) and click on the green button labeled 'Install Steam' located in the top right corner of the website.



Installing SteamVR

Steam should automatically display a pop-up to install SteamVR when you connect your Beyond. If that doesn't happen, search for SteamVR on Steam and install it.

THE BIGSCREEN BEYOND UTILITY

Once you installed SteamVR, Steam will automatically download the Bigscreen Beyond driver. It will install a tiny Bigscreen Beyond app that enables you to enhance your headset experience. The app lets you adjust the refresh rate, brightness, fan speed, and LED color. It will minimize into your system tray when not in use.

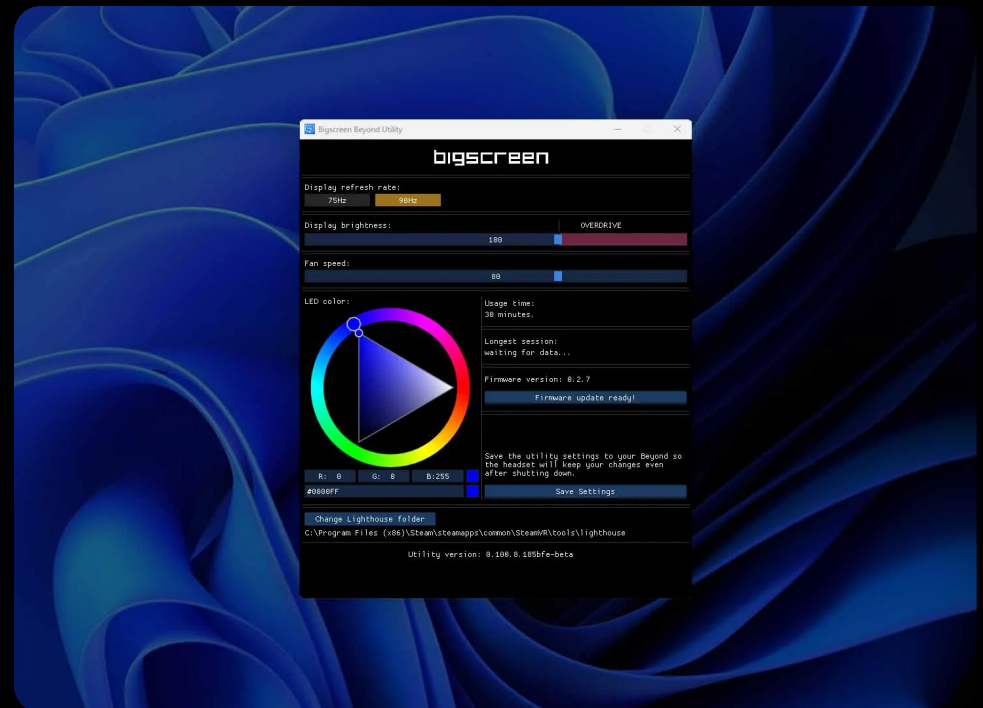

Important: Make sure your Beyond is using the latest firmware
It's essential to keep your Beyond device updated with the latest firmware. Please check the firmware status using the Beyond Utility on your computer. If you see a "Firmware Update Ready" notification, initiate the update by clicking on it.

Critical Reminder: Do not power off or disconnect your Beyond headset during the update. Likewise, avoid touching or shutting down your computer. Any interference can disrupt the update process and impact your device's functionality.

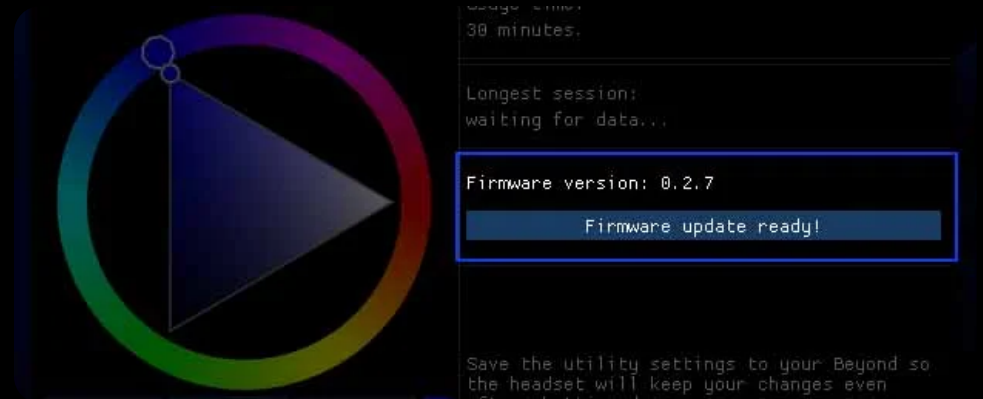

PAIRING YOUR VALVE KNUCKLE CONTROLLERS

Although the Valve Index™ Knuckle Controllers are not included, the following instructions detail how to pair them with your device.

Pair your controllers

Launch SteamVR by clicking the VR button in the upper corner of Steam. To pair your controllers with your VR Headset, Select Devices > Pair Controller. Follow the onscreen instructions to complete the process. Once paired, use the system button to turn on your controllers and launch SteamVR. Note: Your controllers are partially charged for a few hours of playtime. To charge them, use the provided USB cables.

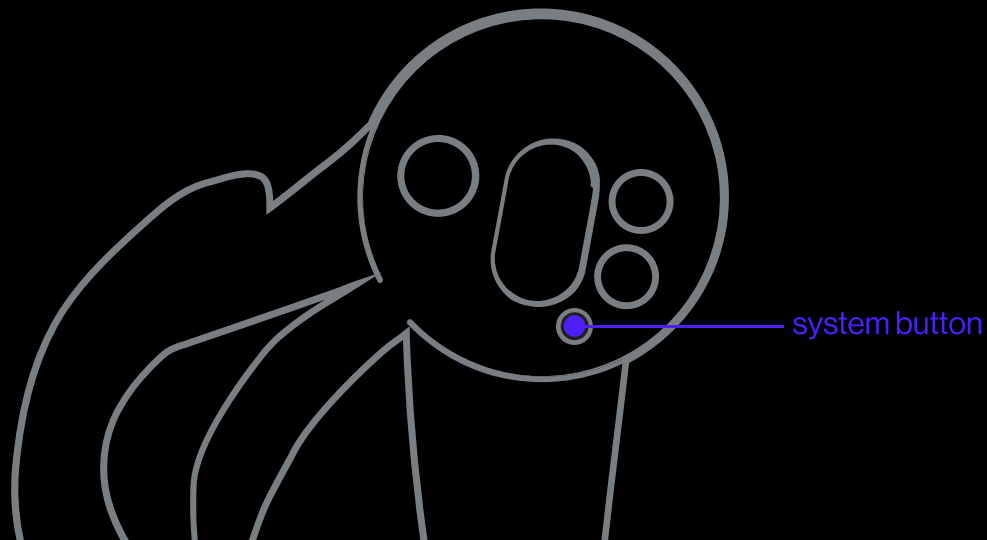

CLEANING AND MAINTENANCE

Maintaining your Bigscreen Beyond VR headset is vital for preserving its longevity and ensuring the best user experience. Proper care will prevent damage to sensitive components and keep your VR experience clear and immersive. Here's a comprehensive guide on how to do so:

General Precautions



Never use Alcohol or Liquids

For the longevity of your Beyond, it's crucial to steer clear of cleaning with alcohol (IPA) and any other liquids. These substances can damage the electronics, exterior shell, and optics.



Keep Out of Direct Sunlight

Sunlight, although seemingly harmless, can destroy your Beyond's optics and displays. The optics act as a magnifying glass and sunlight can permanently damage the display and optics. Ensure you store your Beyond away from any sunlight.



Avoid Extreme Temperatures

For the longevity and optimal performance of your VR headset, always keep it away from very hot or cold environments. Store in a moderate temperature setting to protect its delicate components.

Cleaning and Maintaining the Optics of Your Beyond

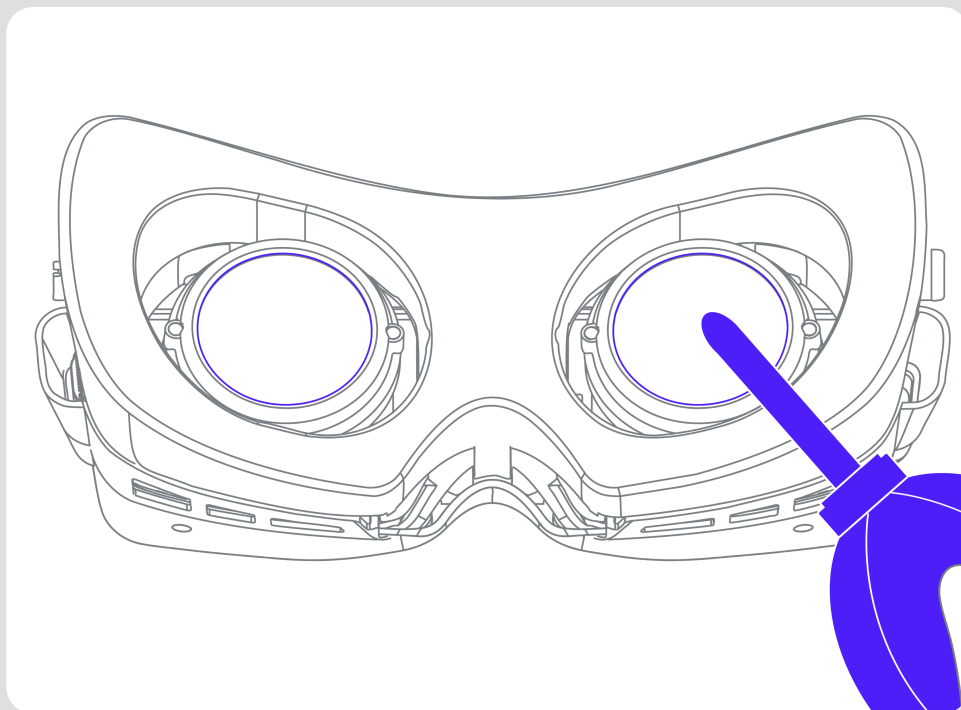

Using a Camera Lens Blower for Dust Removal

Before you proceed with cleaning the lenses, it's recommended to use a camera lens blower to gently remove any surface dust. This simple step ensures that the lenses remain scratch-free during the cleaning process.

Note: Please avoid using compressed air for this purpose. Only a dedicated camera lens blower is advised to ensure safe and effective dust removal.

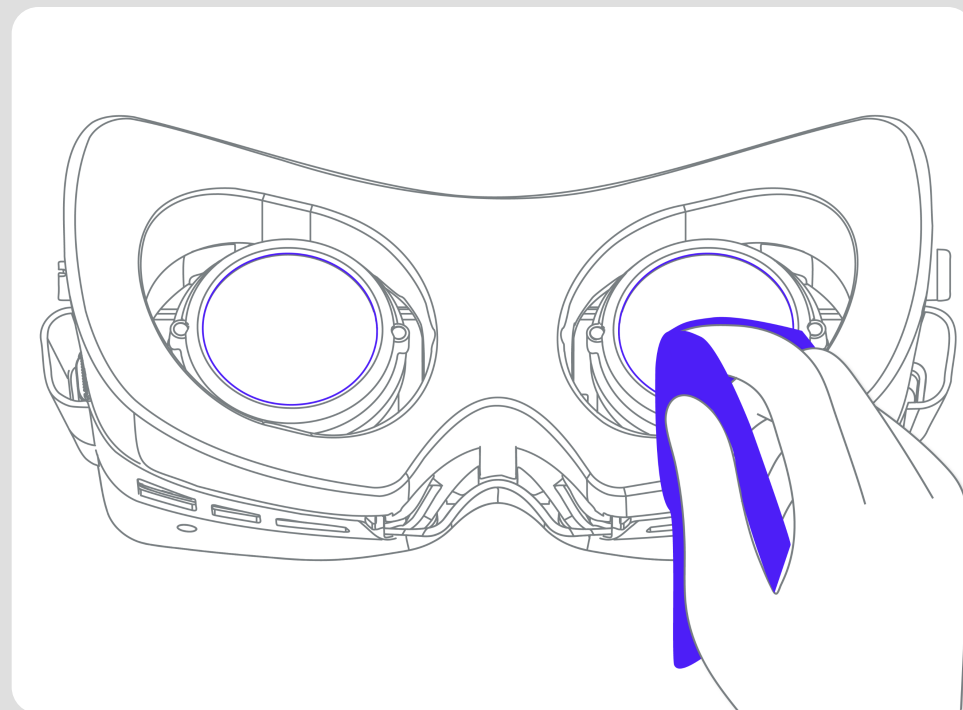

Cleaning the optics with a Dry Microfiber Cloth

For optimal clarity, gently clean the lenses in a circular motion using a soft, dry microfiber cloth designed for optics. Be cautious not to apply excessive pressure, and never use cleaning alcohol or other liquids, as these can damage the sensitive components.

Cleaning your Prescription Lens Inserts

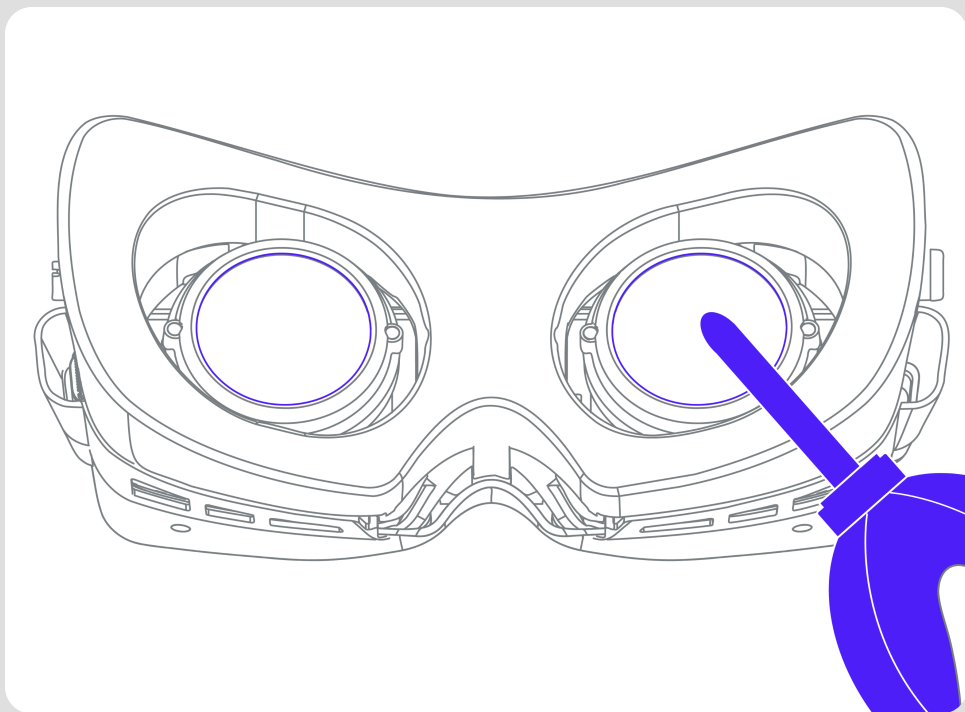

IMPORTANT: Remove Lens Inserts before cleaning

Always begin by removing the lens inserts from the Beyond. Cleaning them while still attached can pose a risk to the optics, potentially leading to damage.

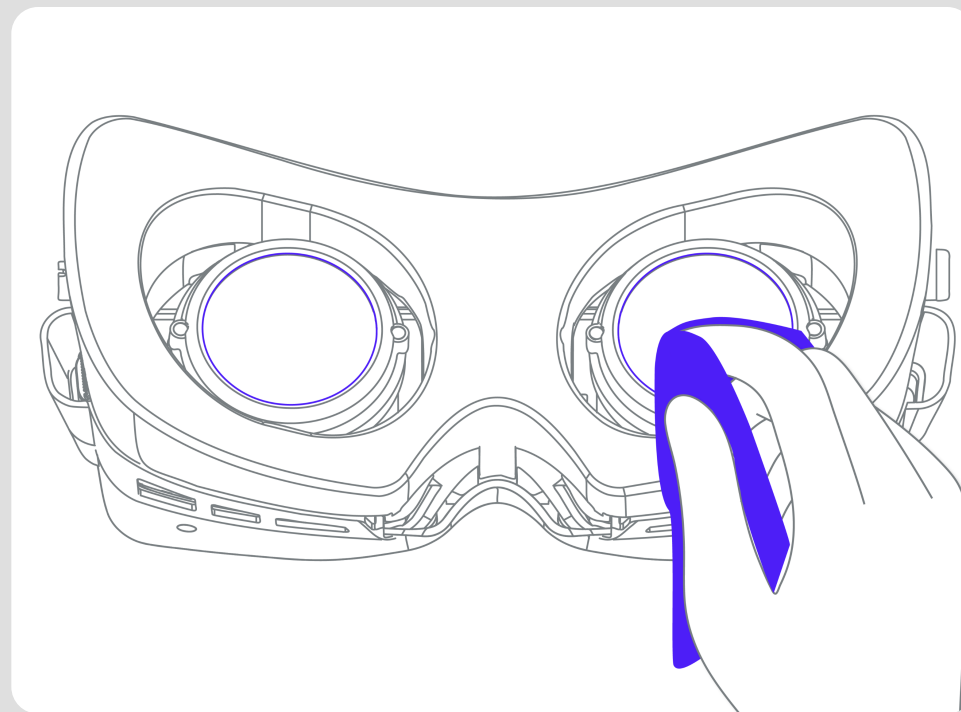

Cleaning the lenses with a Dry Microfiber Cloth

Achieve the clearest view by gently wiping the lenses in a circular pattern with a soft, dry microfiber cloth specifically made for optical use. It's crucial not to exert too much pressure. Remember, cleaning alcohol and other liquids are a no-go; they can harm the delicate parts of the inserts.

Cleaning your Personalized Beyond Face Cushion

IMPORTANT: Remove Lens Inserts before cleaning

Always begin by removing the lens inserts from the Beyond. Cleaning them while still attached can pose a risk to the optics, potentially leading to damage.

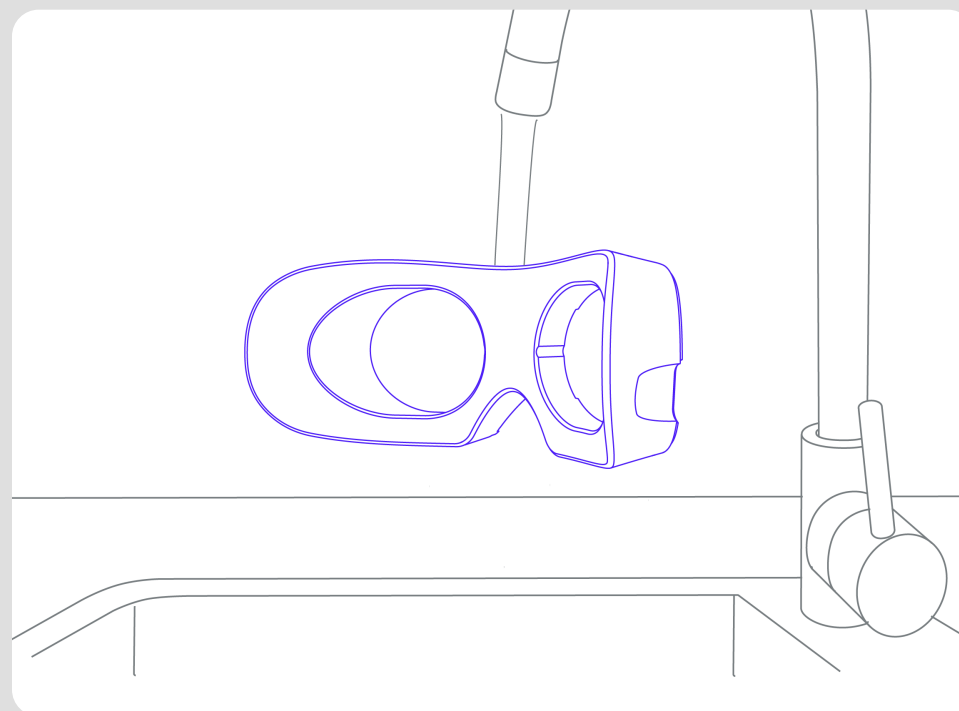

IMPORTANT INFORMATION

FCC RF Radiation Exposure Statement Caution: To maintain compliance with the FCC's RF exposure guidelines, place the product at least 0cm from nearby personsr

TRADEMARKS AND COPYRIGHTS

© 2023 Bigscreen Inc. Bigscreen and the Bigscreen logo are trademarks of Bigscreen Inc. Steam, the Steam logo, and SteamVR are trademarks of Valve Corporation.